

1:10

Drawing is for reference dimensions only and subject to change.

Cantoni[®]
GROUP

CELMA
indukta

SIE360T4_6

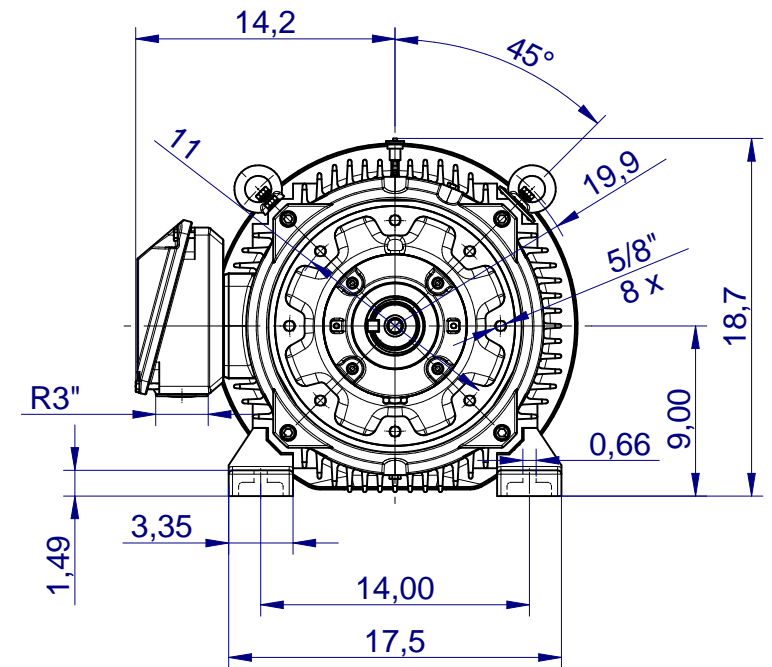
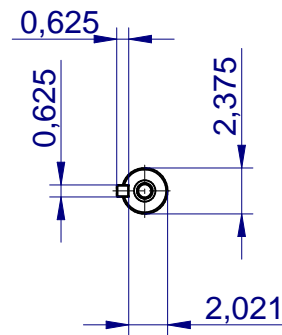
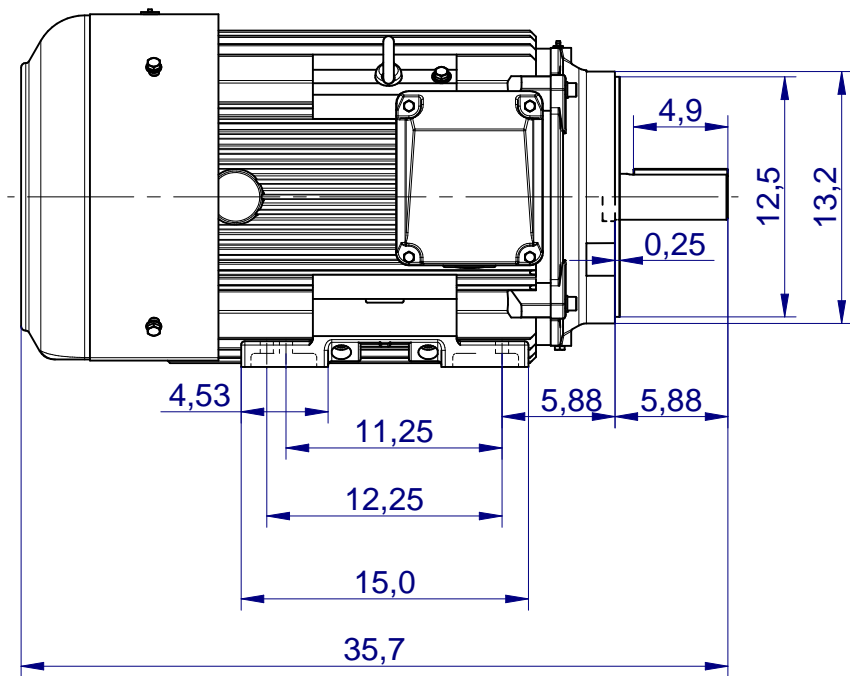

1:10

Drawing is for reference dimensions only and subject to change.

Cantoni[®]
GROUP

CELMA
indukta

SIE360TCL 4_6

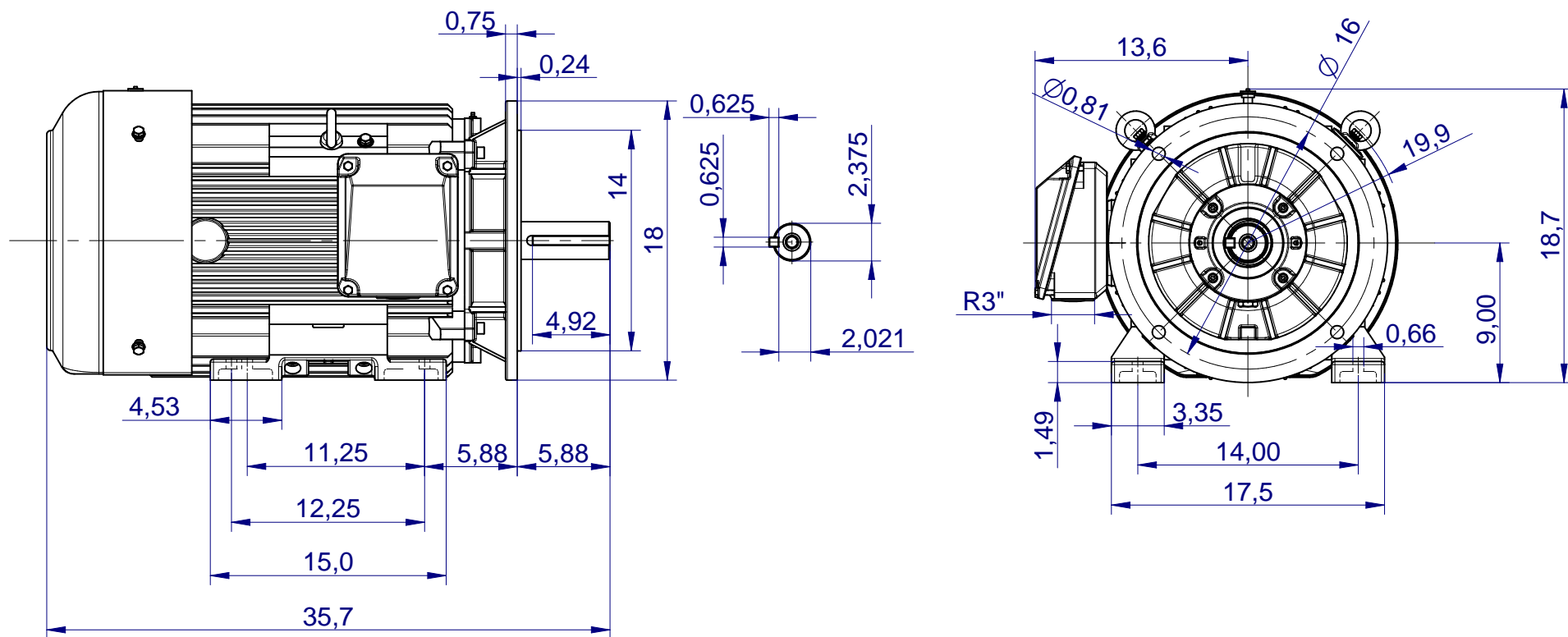

1:10

Drawing is for reference dimensions only and subject to change.

Cantoni[®]
GROUP

CELMA
indukta

SIE360TDL 4_6